

Hyundai R17Z-9A

Specifications

Net power 15.8 hp
(11.8 kW) at 2,300 rpm

Bucket breakout force
(ISO) 1,580 kgf / 3,490 lbf

Operating weight
1,780 kg (3,920 lb)

Arm Digging Force
(ISO) 870 kgf / 1,920 lbf

ENGINE

MODEL	KUBOTA D902	
Type	Water-cooled, 4-cycle diesel 4 cylinders in line, diesel, low emission	
Rated flywheel horsepower	SAE J1995 (gross)	16.8 hp (12.5kw) @ 2,300 rpm
	J1349 (net)	15.8 hp (11.8kw) @ 2,300 rpm
Max. torque	5.6 kgf·m (36 lbf·ft) at 1,900 rpm	
Bore X stroke	72 mm (2.83") x 73.6 mm (2.89")	
Piston displacement	898 cc (54.79 in ³)	
Battery	1 x 12V x 45 Ah	
Starting motor	12V – 1.2 kW	
Alternator	12V – 40 Amp	

HYDRAULIC SYSTEM

MAIN PUMP	
Type	Variable-displacement piston pumps + gear pump
Max. flow	2 x 18.8 ℓ/min (5 gpm) + 11.3 ℓ/min (3 gpm) at 2,500 rpm
Sub-pump for pilot circuit	Gear pump

Cross-sensing and fuel-saving pump system

HYDRAULIC MOTORS

Travel	Two-speed axial piston motor with counter balance valve and parking brake
Swing	Axial piston motor with automatic brake

RELIEF VALVE SETTING

Implement circuits	210 kgf/cm ² (2,990 psi)
Travel circuit	210 kgf/cm ² (2,990 psi)
Swing circuit	135 kgf/cm ² (1,920 psi)
Pilot circuit	30 kgf/cm ² (430 psi)
Service valve	Installed

HYDRAULIC CYLINDERS

No. of cylinders bore X stroke	Boom: 60 x 440 mm (2.3" x 17.3")
	Arm: 60 x 353 mm (2.3" x 13.8")
	Bucket: 55 x 320 mm (2.16" x 12.59")
	Boom swing: 55 x 355 mm (2.16" x 13.97")
	Dozer blade: 65 x 115 mm (2.6" x 4.5")
Extension: 55 x 310 mm (2.16" x 12.2")	

TRAVEL SYSTEM

Drive method	Full hydrostatic type
Drive motor	Axial piston motor, in-shoe design
Reduction system	Planetary reduction gear
Max. drawbar pull	1,420 kgf (3,130 lbf)
Max. travel speed (high) / (low)	2.2 km/hr (1.4 mph) / 4.1 km/hr (2.5 mph)
Gradeability	30° (58%)
Parking brake	Multi-wet disc

CONTROLS

Pilot-pressure-operated joysticks and pedals with detachable lever provide almost effortless and fatigueless operation.

Pilot control	Two joysticks with one safety lever (LH): Arm swing, boom swing (RH): Boom and bucket (ISO)
Traveling and steering	Two levers with pedals
Engine throttle	Mechanical, cable type

SWING SYSTEM

Swing motor	Orbit motor
Swing bearing lubrication	Lubricated with drain
Swing speed	9.5 rpm

COOLANT AND LUBRICANT CAPACITY

(Refilling)	liter	gal
Fuel tank	20	5.3
Engine coolant	3.5	0.9
Engine oil	3.7	1.0
Hydraulic tank	13	3.4
Hydraulic system	23	6.1

WEIGHT (APPROXIMATE)

Operating weight, including 1,800 mm (5' 11") boom, 960 mm (3' 2") arm, SAE heaped 0.04 m³ (0.05 yd³) excavator bucket, 230 mm (9") rubber track, lubricant, coolant, full fuel tank, hydraulic tank, 268 kg (590 lb) counterweight and the standard equipment.

Operating weight (canopy)	1,780 kg (3,920 lb)
Ground pressure (canopy)	0.26 kg/cm ² (3.70 psi)

UNDERCARRIAGE













Center frame is integrally welded with reinforced box-section track frames. The undercarriage includes lubricated rollers, track adjusters with shock absorbing springs and sprockets, and rubber shoes.

Track frame	Variable undercarriage
No. of track roller on each side	3 ea

 Rating over front  Rating over side or 360 degree

R17Z-9A Lifting Capacity ISO Condition 2

Boom: 1.80 m (5' 11") / Arm: 0.96 m (3' 2") / Bucket: 0.04 m³ (0.05 yd³) SAE heaped / Dozer down / Rubber track 230 mm (9") / Counterweight 268 kg (590 lb)

Lift-point height m (ft)	Lift-point radius										At max. reach			
	1.0m (3.3ft)		1.5m (4.9ft)		2.0m (6.6ft)		2.5m (8.2ft)		3.0m (9.8ft)		Capacity		Reach m(ft)	
														
2.5 m 8.2 ft	kg						*360	*360			*340	*340	2.70	
	lb						*800	*800			*740	*740	(8.9)	
2.0 m 6.6 ft	kg						*370	*370	*370	290	*320	280	3.04	
	lb						*830	*830	*830	640	*700	620	(10.0)	
1.5 m 4.9 ft	kg		*730	*730	*510	*510	*430	380	*390	290	*320	250	3.25	
	lb		*1,610	*1,610	*1,130	*1,130	*940	840	*860	630	*700	550	(10.6)	
1.0 m 3.3 ft	kg				*680	510	*500	370	*420	280	*330	240	3.34	
	lb				*1,500	1,130	*1,100	810	*920	620	*730	520	(11.0)	
0.5 m 1.6 ft	kg				*800	490	*560	360	*450	270	*360	230	3.34	
	lb				*1,770	1,080	*1,240	780	*990	600	*790	520	(10.9)	
0.0 m 0.0 ft	kg		*580	*580	*830	480	*590	350	*460	270	*410	240	3.24	
	lb		*1,290	*1,290	*1,830	1,060	*1,310	770	*1,010	590	*900	530	(10.6)	
-0.5 m -1.6 ft	kg	*720	*720	*1,000	770	*790	480	*570	350	*430	270	*420	270	3.03
	lb	*1,580	*1,580	*2,210	1,700	*1,740	1,060	*1,260	760	*940	590	*920	590	(9.9)
-1.0 m -3.3 ft	kg	*1,110	*1,110	*970	780	*680	480	*490	350		*420	320	2.68	
	lb	*2,440	*2,440	*2,140	1,720	*1,500	1,070	*1,070	770		*930	700	(8.8)	
-1.5 m -4.9 ft	kg			*630	*630	*430	*430				*400	*400	2.08	
	lb			*1,390	*1,390	*950	*950				*870	*870	(6.8)	

Notes:

- Lifting capacities are based on ISO 10567.
- Lifting capacities of the 9A Series does not exceed 75% of tipping load with the machine on firm, level ground or 87% of full hydraulic capacity.

- The Lift-point is bucket pivot mounting pin on the arm (without bucket mass).
- (*) indicates load limited by hydraulic capacity.

Dimensions & Working Range

R17Z-9A DIMENSIONS

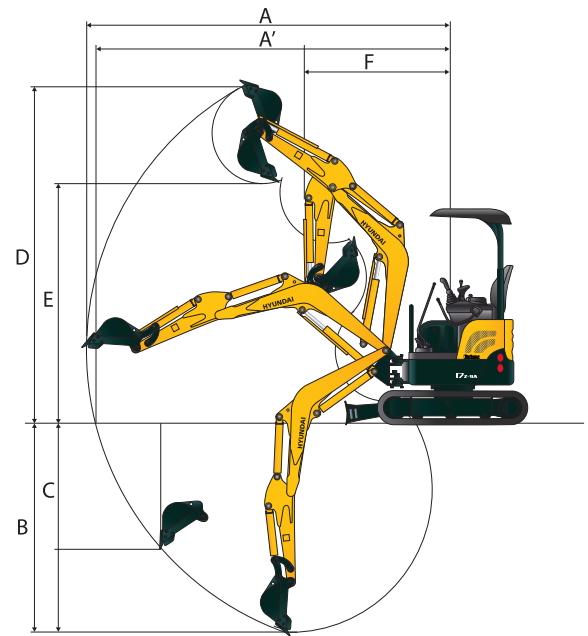
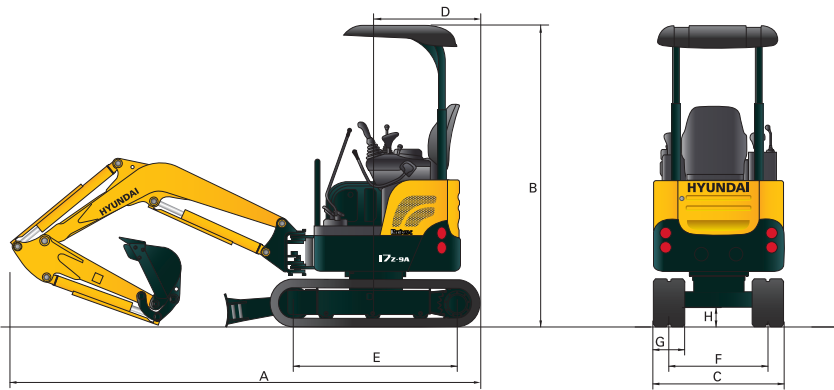

R17Z-9A DIMENSIONS

	mm	(ft-in)
A Overall length	3,480 [3,510]	(11'4")
B Overall height	2,320	(7'7")
C Overall width	990~1,300 (3'2" - 4'2")	
D Tail swing radius	645 (2'11") 720 (2'3")	(With additional counterweight)
E Tumbler distance	1,230	(4'0")
F Track gauge	760~1,070 (2'6"~3'5")	
G Track shoe width	230	(0'9")
H Ground clearance	170	(0'5")

R17Z-9A WORKING RANGE

	mm	(ft-in)
Boom length	1,800	(5'11")
Arm length	960	(3'2")
A Max. digging reach	3,900	(12'7")
A' Max. digging reach on ground	3,800	(12'4")
B Max. digging depth	2,200	(7'2")
C Max. vertical wall digging depth	1,320	(4'3")
D Max. digging height	3,580	(11'7")
E Max. dumping height	2,570	(8'4")
F Min. swing radius	1,570	(5'1")

STANDARD EQUIPMENT

Canopy TOPS ISO 12117
(ROPS ISO 12117-2)
FOG ISO 10262 Level I
(FOPS ISO 3449 Level I)

Centralized monitoring
Gauges
Fuel-level gauge
Engine coolant temperature gauge

Warning indicator

- Quick clamp
 - Engine oil pressure
 - Engine coolant temperature
 - Preheat
 - Low battery
 - Fuel empty
- One key
Mechanical suspension seat with seat belt
Console box tilting system (LH)
Two front working lights
Electric horn
Battery (1 x 12 V x 45 AH)
Battery master switch

- Removable reservoir tank
- Water separator, fuel line
- Mono boom (1.80 m / 5' 11")
- Arm (0.96 m / 3' 2")
- Rubber track shoes (230 mm / 9")
- Double-acting piping
- Travel alarm
- Pattern-change lever
- Quick coupler and piping
- Additional counterweight (414 kg / 177 lbs)
- Hyundai bucket (0.04 m³ / 0.05 yd³)

OPTIONAL EQUIPMENT

- Accumulator
- Long arm (1.12 m / 3'8")
- Proportional control switch



www.hceamericas.com

6100 Atlantic Blvd., Norcross, GA 30071

TEL (678) 823-7777 FAX (678) 823-7778

Printed in U.S.A.

1038-EX-SP 11/2016